



Plate Brackets (MISUMI)



Part Number **HFBL5-2020-464**

20220515224615

Material	A6N01SS-T5 Aluminum Alloy	Surface Finish	Clear Anodize
Extrusion Series	HFS	Extrusion No.	5
Extrusion Size	For 2020	Bracket Type	Brackets for Reinforcement
Applicable Screws	M5 Screws	Number of Extrusion Connection Holes	2
Overall Length L(mm)	464	-	-

(No surface treatment on 45° cut ends and counterbores.)

HFBL5-2020
HFBL5-2040

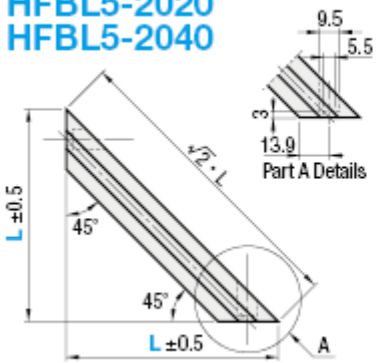

HFBL5-4020

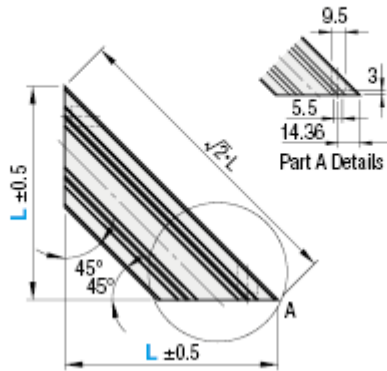

<Front View>
HFBL5-2020
HFBL5-4020



<Front View>
HFBL5-2040

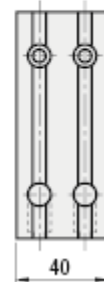

Alterations	Code	Spec.	Applicable Bracket
Set of Applicable Screws and Nuts	SET SST (Stainless Steel)	Applicable screws and nuts for fixing the brackets on extrusions come in a set. (Adds to the bracket price) (Ex.) When HFBL5 is specified	HFBL5-2020
	SEU (Pre-Assembly Insertion Spring Nuts)		
	SSU (Pre-Assembly Insertion Spring Nuts Stainless Steel)		HFBL5-2040
	SEP (Post-Assembly Insertion Spring Nuts)		
	SSP (Post-Assembly Insertion Spring Nuts Stainless Steel)		HFBL5-4020

⚠ Not RoHS compliant when -SET, -SEU and -SEP are specified.